

# Pankaj<sup>★</sup>



MAKE IN INDIA



## Foot Operated Potentiometer Model: FOP

An innovative product from PANKAJ, Foot Operated Potentiometer model FOP, using Pankaj Make Short Stroke Conductive Plastic Potentiometers LCP-10 for linear control.

### Material Used

- ◆ Conductive plastic potentiometers
- ◆ Gold Plated PCB
- ◆ Gold Plated Terminals
- ◆ Gold Plated Wiper Contact
- ◆ Heavy Duty Aluminum Casting Housing

### Features

- ◆ Hands Free Operation
- ◆ 2NO+2NC 10 Amp Heavy Duty Switch
- ◆ 5K or 10Kohms LCP-10
- ◆ Long Life
- ◆ Infinite Resolution

### Operation

On pressing the foot pedal, switch of 230VAC 10 Amp 2NC+2NO with isolated phase and neutral operates first, followed with potentiometer resistance variation. On releasing foot pedal, the potentiometers resistance changes, comes to its original position then switch contacts is put OFF.

### Applications

- ◆ Potentiometer control,
- ◆ Welding,
- ◆ Coil Winding,
- ◆ Potentiometric control with hands free operation,
- ◆ Potter's Wheel,
- ◆ Motor speed variation & many more



Standard Cover

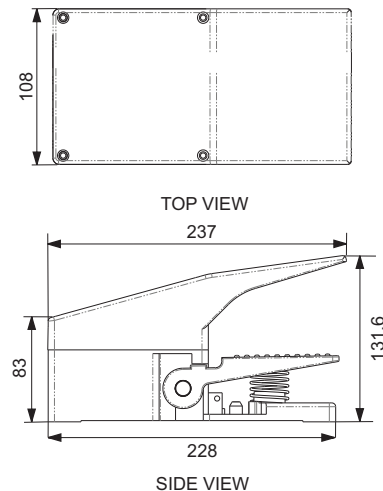

ALL DIMENSIONS ARE IN MM

**Foot Operated Potentiometer  
Model: FOP**

**Product Images**

**Dimensional Diagram**



Flat Cover

TOP VIEW

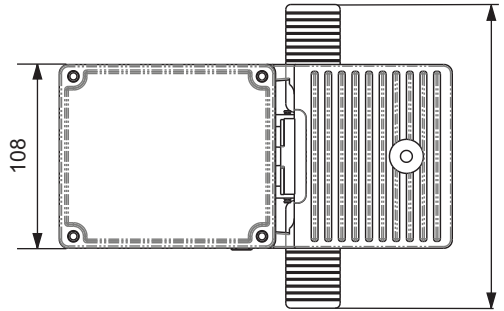

SIDE VIEW

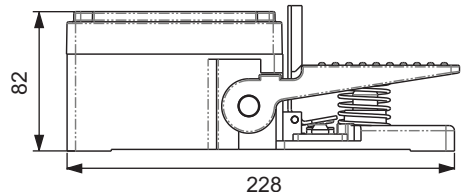

ALL DIMENSIONS ARE IN MM

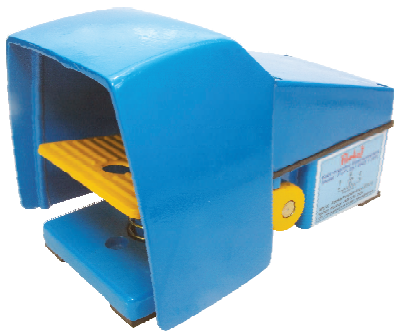

Dome Shape Cover

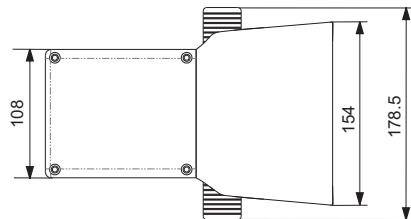

TOP VIEW

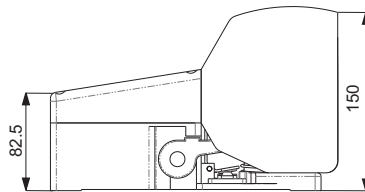

SIDE VIEW

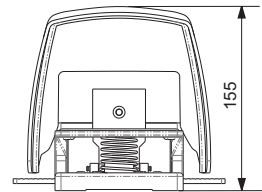

FRONT VIEW

ALL DIMENSIONS ARE IN MM

**Manufacturers & Exporters**

**PANKAJ POTENTIOMETERS PVT. LTD.**

**MUMBAI-INDIA**

URL: [www.pankaj.com](http://www.pankaj.com)

Email : [pankaj.potentiometers@gmail.com](mailto:pankaj.potentiometers@gmail.com)

Note: We reserve the right to make any kind of design, specifications or functional modification at any moment without prior notice